

ORDO



SONIC LITE
CHARGING ELECTRIC TOOTHBRUSH

User Guide

Brush Set-Up

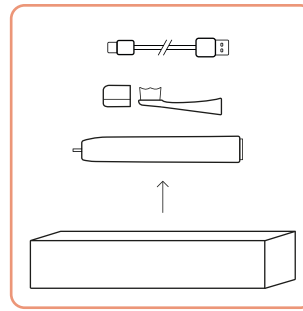

1

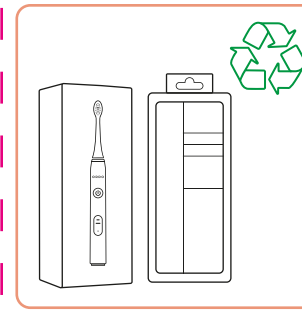

2

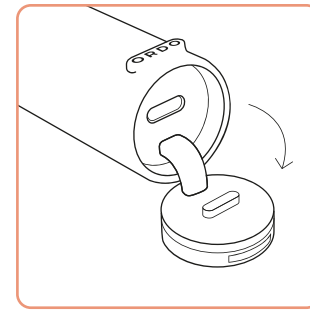

3



4

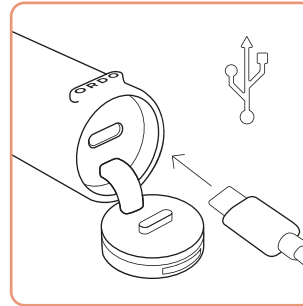

5

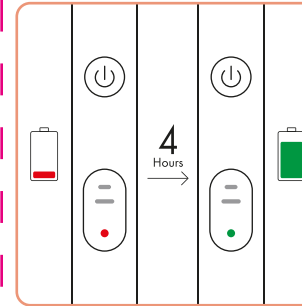

6

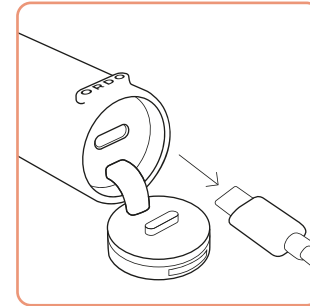

7

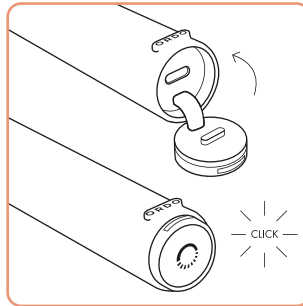

8

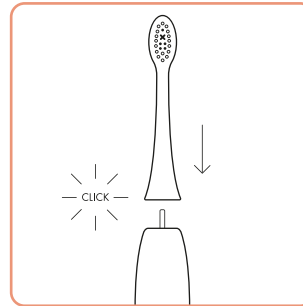

9

Using Your Brush

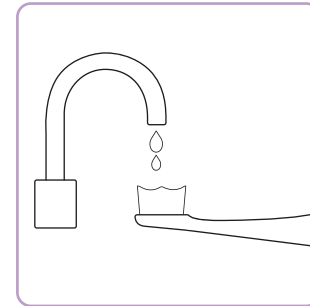

1

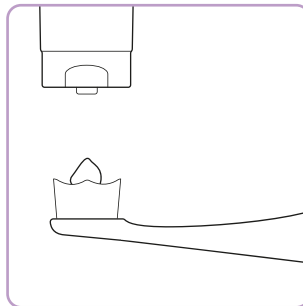

2

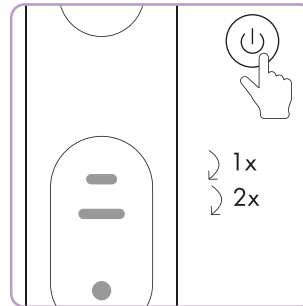

3

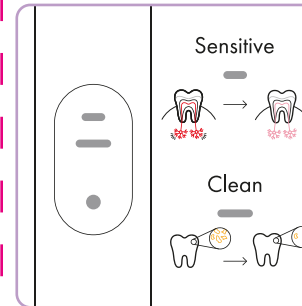

4

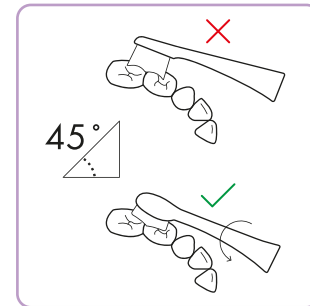

5

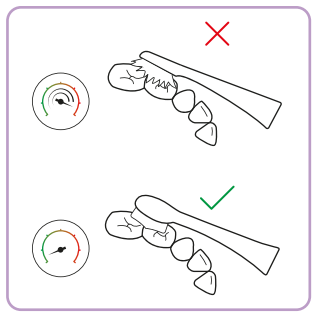

6

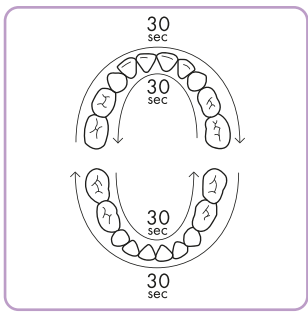

7

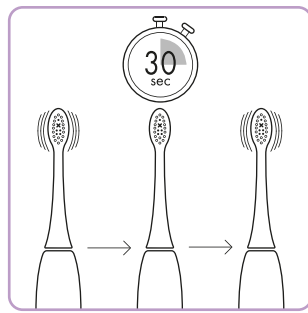

8

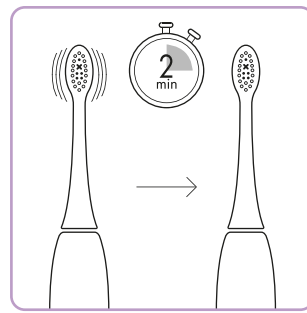

9

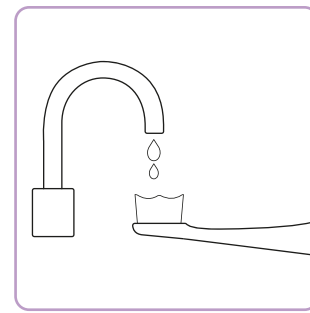

10

Charging Your Brush

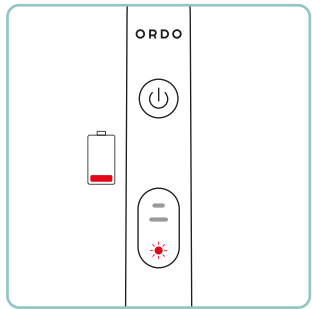

1

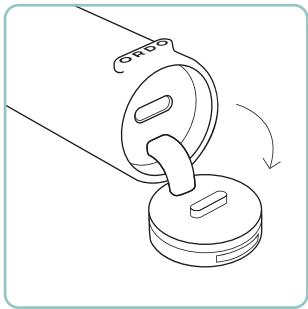

2



3

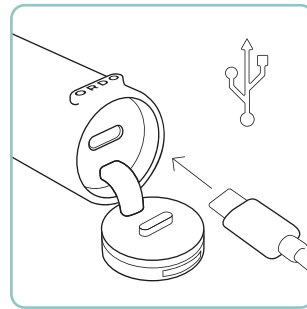

4

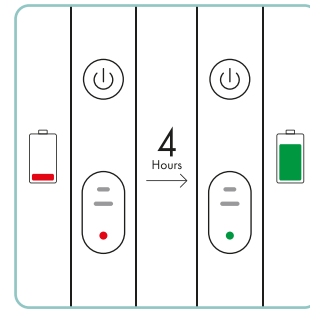

5

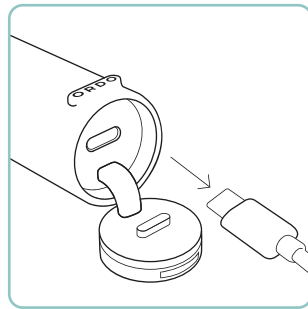

6

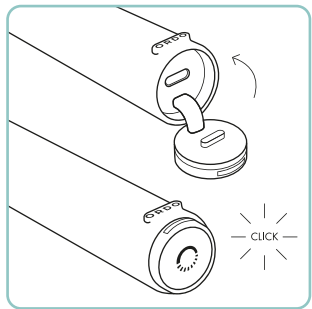

7

Changing Your Brush Head

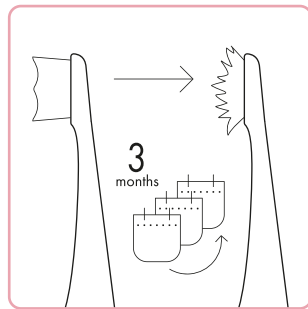

1

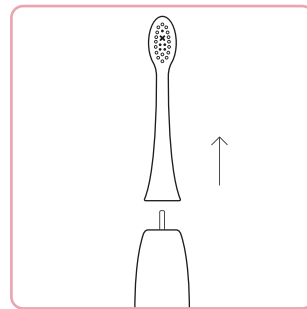

2

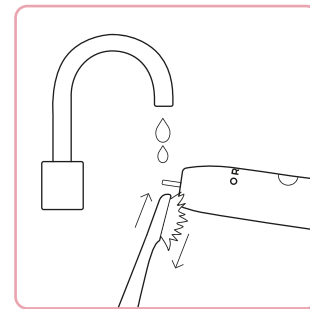

3

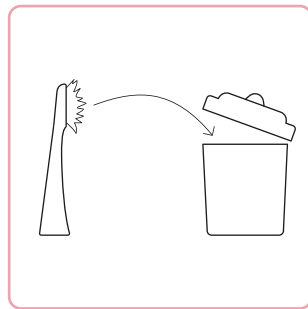

4

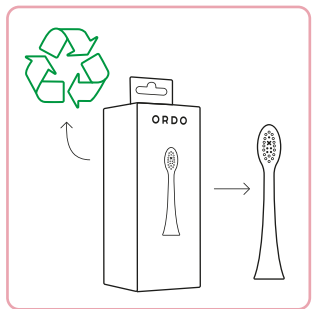

5

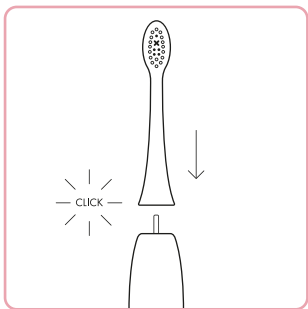

6

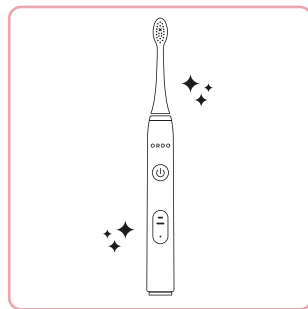

7

More Information

